

# Perfect 10 Hybrid Displays

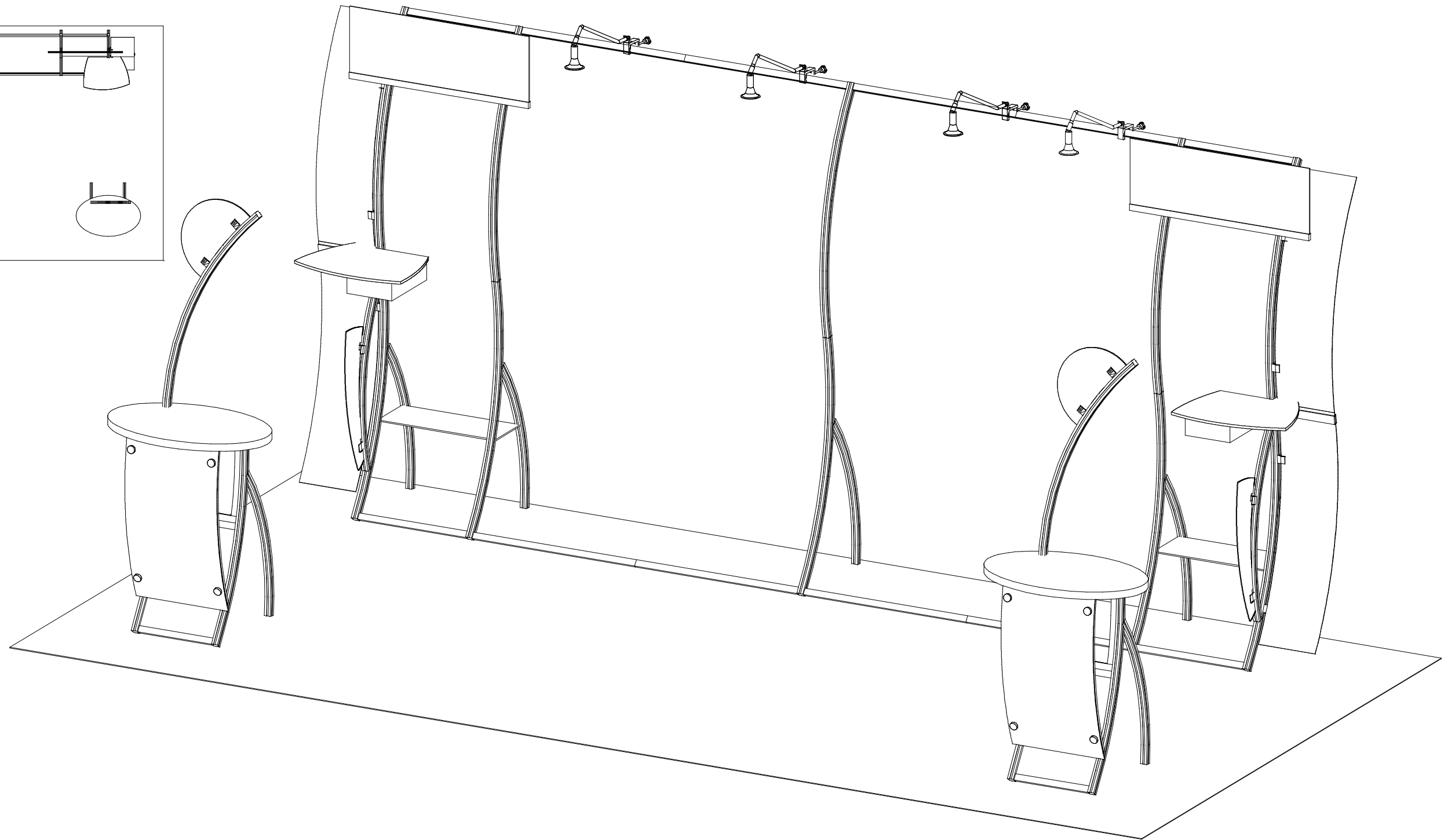
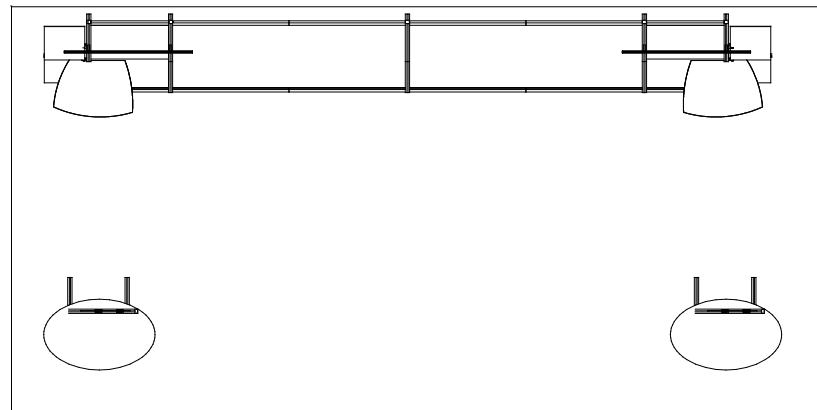

WHEN DISASSEMBLING TIGHTEN ALL KNOBS TO PREVENT LOSS DURING SHIPPING

866.652.2100

Part Number	Description
1	Left Leg Assembly w/ A10 Clamps Attached
2	Middle Leg Assembly
3A	Upper Curved Vertical w/ A10 Clamps Attached
3	Upper Curved Vertical
4	23" w Horizontal



Step 1:

NOTE: Can be assembled either face down on floor then lifted upright or upright as shown in drawings.

- A) Connect vertical leg assemblies [1 and 2] together by connecting horizontal extrusions [4] between assemblies tightening BLACK knobs on backside of extrusion making sure Velcro faces toward BACK and placing it about one inch up from bottom and tightening.
- B) Connect vertical extrusions [3 and 3A] to leg assemblies [1 and 2] using vertical connection bar as shown.
- C) Connect upper horizontal extrusion [4] between verticals [3 and 3A] placing it about one inch down from top.

**NOTE: Make sure the lock is flush with extrusion before tightening. If lock will not fully engage, gently rock lock and extrusion while turning knob until lock fully opens.**

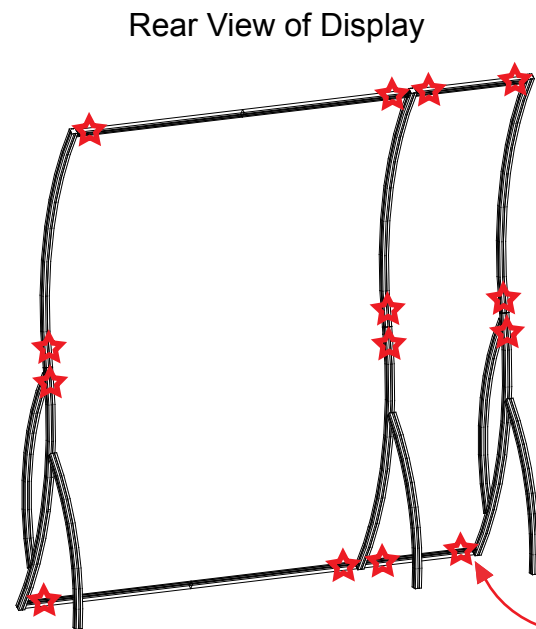

STAR indicates location of knobs on BACKSIDE of unit.

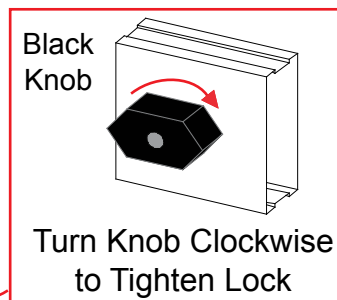

Turn Knob Clockwise to Tighten Lock

Step 1

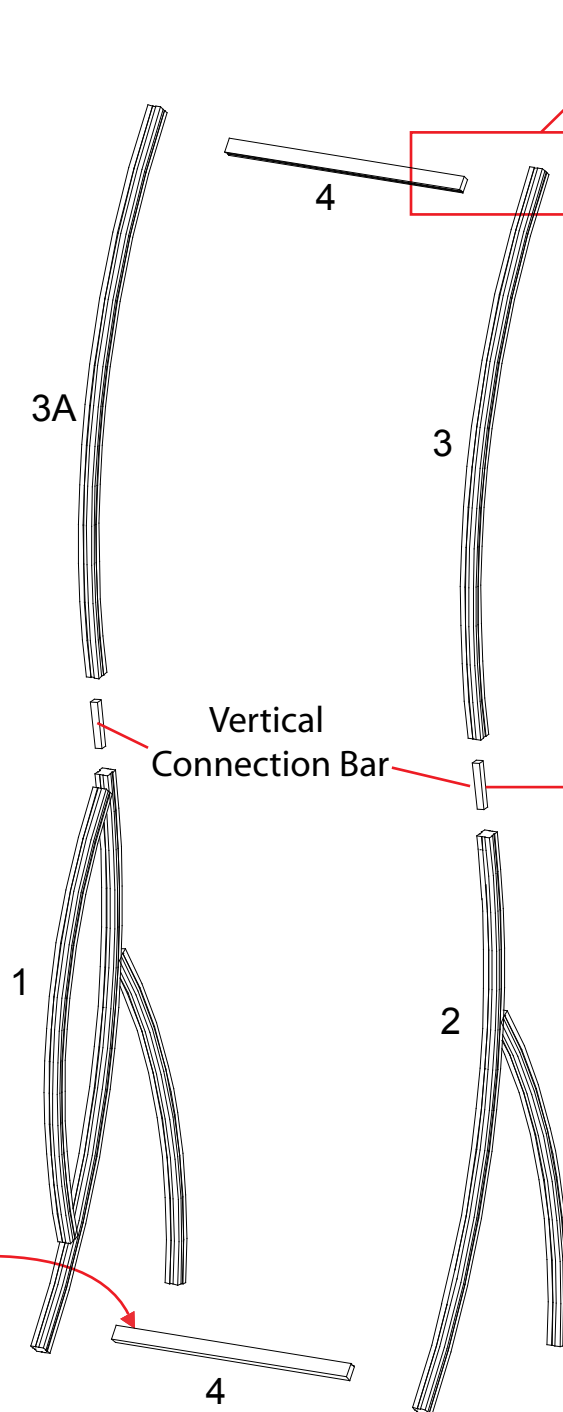

NOTE: When assembling horizontals they should be placed approximately one inch from TOP and BOTTOM.



Slide Connection Bar into lower leg assembly. Slide upper vertical over bar and secure both.

Step stool may be required for assembly.



WHEN DISASSEMBLING TIGHTEN ALL KNOBS TO PREVENT LOSS DURING SHIPPING

866.652.2100

Part Number	Description
5	Right Leg Assembly w/ A10 Clamps Attached
6	Upper Curved Vertical
7	69" w Horizontal w/ Hinge Facing UP
8	69" w Horizontal w/ Hinge Facing DOWN



Step 2:  
NOTE: Can be assembled either face down on floor then lifted upright or upright as shown in drawings.

- A) Connect vertical extrusion [6] to leg assembly [5] using vertical connection bar as shown.
- B) Connect horizontal extrusions [7 and 8] between vertical assemblies by tightening BLACK knobs on backside of extrusion making sure Velcro faces toward BACK.

**NOTE: Make sure the lock is flush with extrusion before tightening. If lock will not fully engage, gently rock lock and extrusion while turning knob until lock fully opens.**

NOTE: When assembling horizontals they should be placed approximately one inch from TOP and BOTTOM.

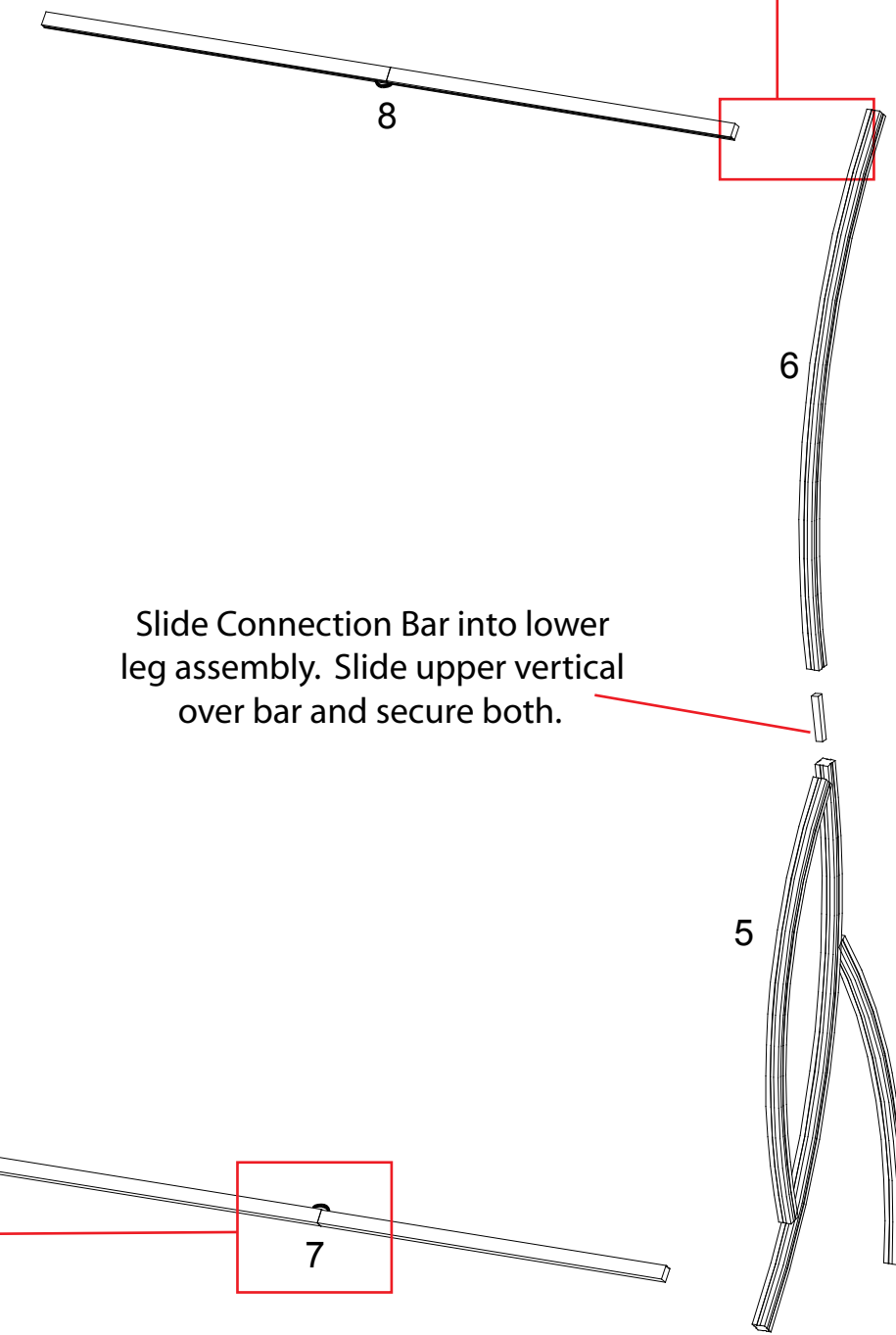

Slide Connection Bar into lower leg assembly. Slide upper vertical over bar and secure both.

Rear View of Display

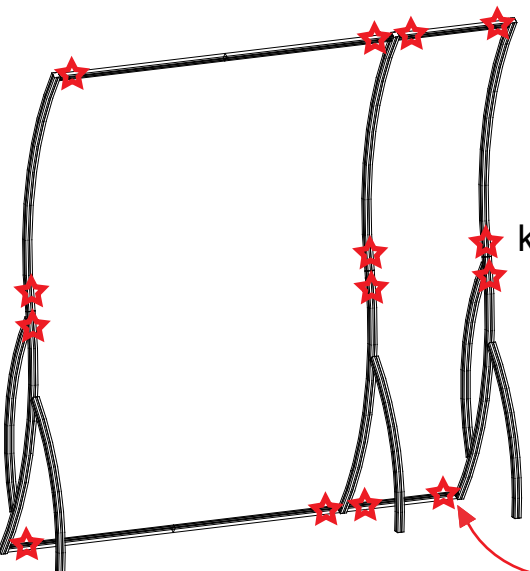

STAR indicates location of knobs on BACKSIDE of unit.

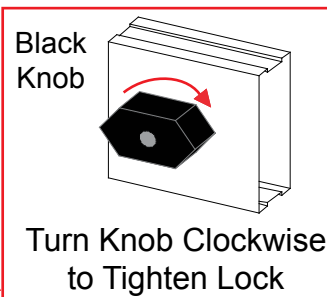

**WHEN DISASSEMBLING TIGHTEN ALL KNOBS TO PREVENT LOSS DURING SHIPPING**

Part Number	Description
9	69" w Horizontal w/ Hinge Facing UP
10	69" w Horizontal w/ Hinge Facing DOWN
11	Middle Leg Assembly
12	Right Leg Assembly w/ A10 Clamps Attached
13A	Upper Curved Vertical w/ A10 Clamps Attached
13	Upper Curved Vertical
14	23" w Horizontal

866.652.2100

NOTE: When assembling horizontals they should be placed approximately one inch from TOP and BOTTOM.



Step 3

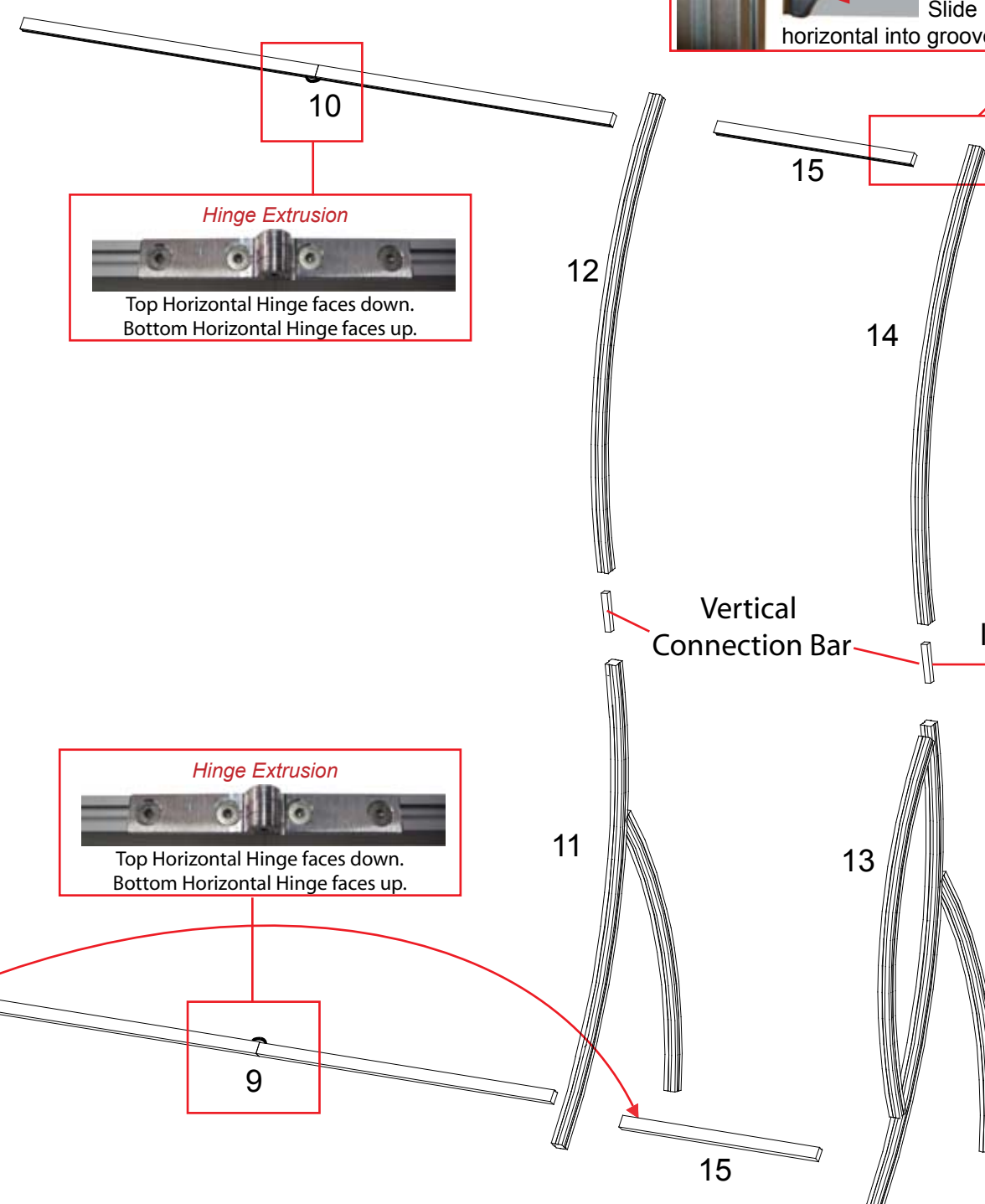

Slide Connection Bar into lower leg assembly. Slide upper vertical over bar and secure both.

Step stool may be required for assembly.



Step 1:

NOTE: Can be assembled either face down on floor then lifted upright or upright as shown in drawings.



- A) Connect vertical leg assemblies [11 and 13] together by connecting horizontal extrusions [15] between assemblies tightening BLACK knobs on backside of extrusion making sure Velcro faces toward BACK and placing it about one inch up from bottom and tightening.
- B) Connect vertical extrusions [12 and 14] to leg assemblies [11 and 13] using vertical connection bar as shown.
- C) Connect upper horizontal extrusion [15] between verticals [12 and 14] placing it about one inch down from top.
- D) Connect horizontal extrusions [9 and 10] between vertical assemblies by tightening BLACK knobs on backside of extrusion making sure Velcro faces toward BACK.

NOTE: Make sure the lock is flush with extrusion before tightening. If lock will not fully engage, gently rock lock and extrusion while turning knob until lock fully opens.

Rear View of Display

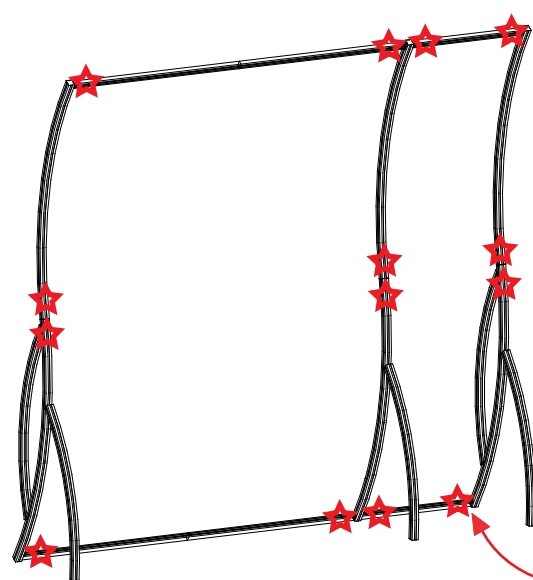

STAR indicates location of knobs on BACKSIDE of unit.

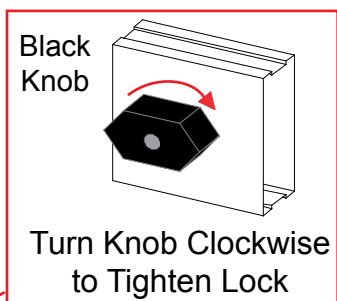

WHEN DISASSEMBLING TIGHTEN ALL KNOBS TO PREVENT LOSS DURING SHIPPING



866.652.2100



**Decorative Blade Attachment  
(if accidentally removed)**  
Slide A10 Clamp into groove of square extrusion.

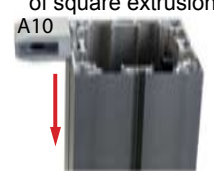

A10

When desired location is found, tighten set screw to secure.



Set-Screw

Attach decorative wing and blades to A10's attached to Backwall as shown.

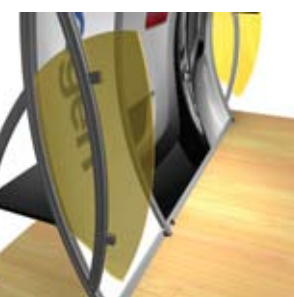



Tighten black plastic set screw to secure Wing in place.



Black Plastic Set-screw

**Hex Key Tool** **Flathead Screwdriver**



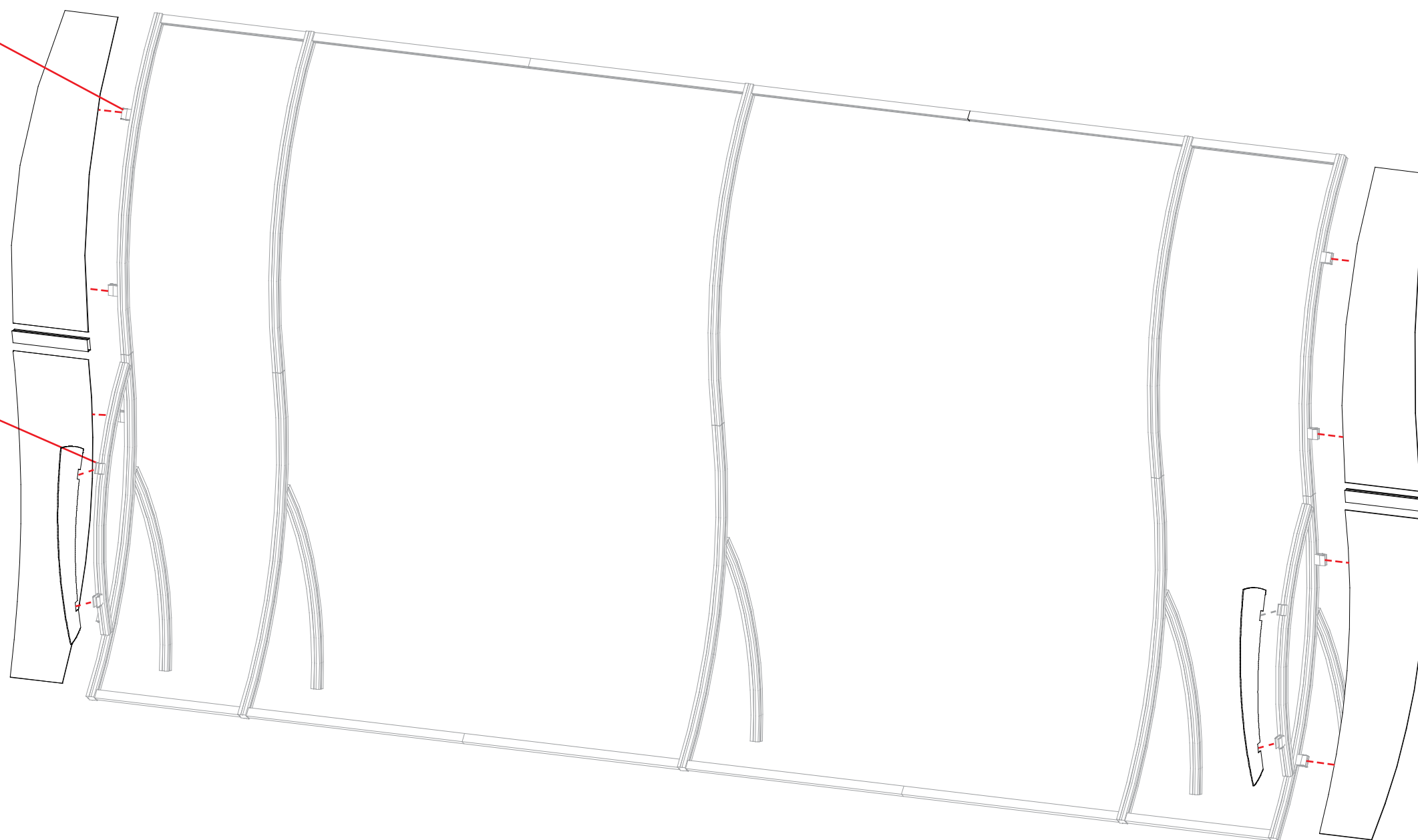

(if necessary)

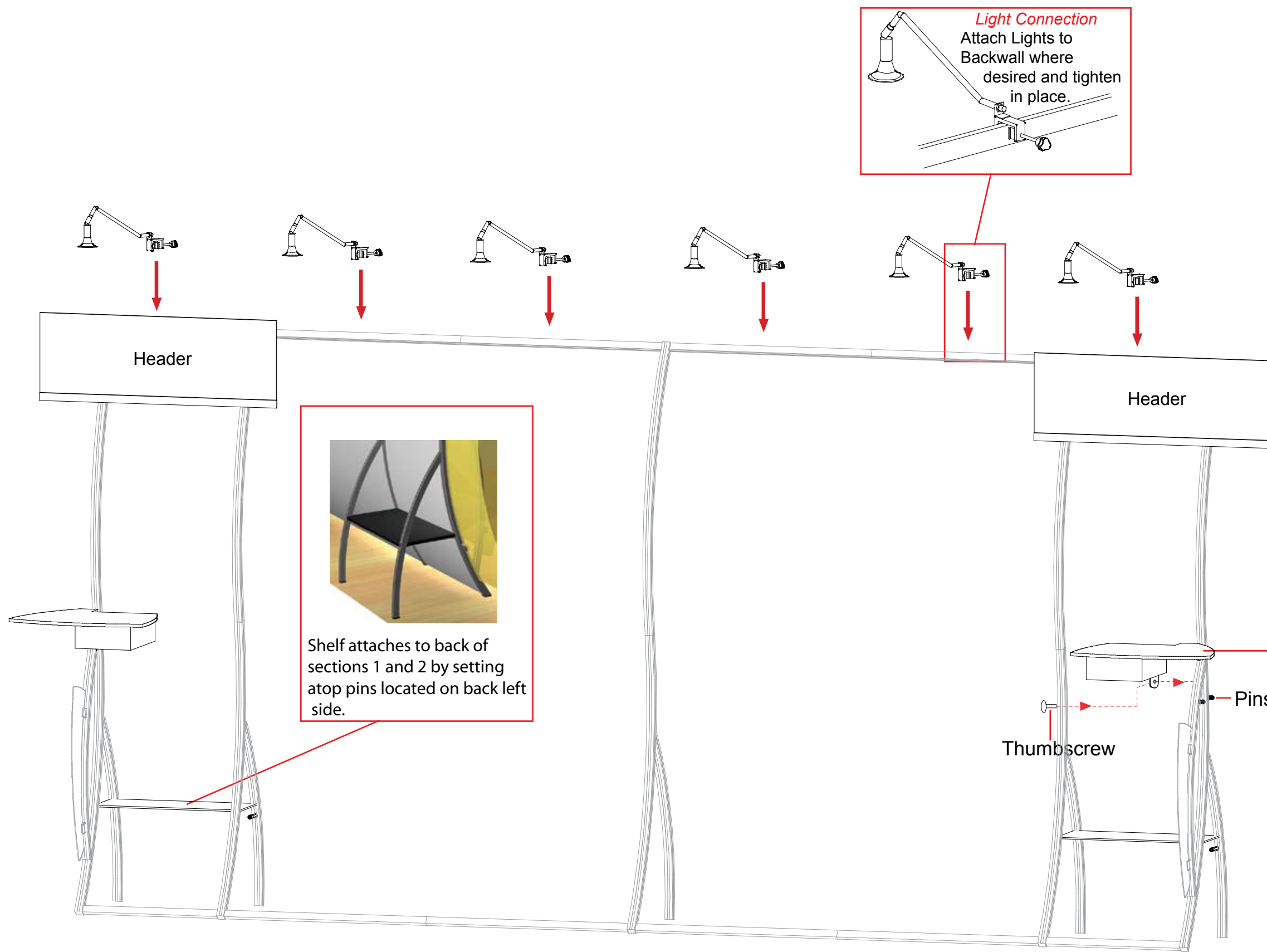

WHEN DISASSEMBLING TIGHTEN ALL KNOBS TO PREVENT LOSS DURING SHIPPING

866.652.2100



**Light Connection**  
 Attach Lights to Backwall where desired and tighten in place.

**Accessory Attachment**  
 Attach Header support then Slide header into Groove

Shelf attaches to back of sections 1 and 2 by setting atop pins located on back left side.

**Cubby Attachment**  
 Shelf attaches to section 5 by setting atop pins located on right side and securing into place with thumbscrew on left.

Slide onto back pin first.

When attaching counter you will need to first slide shelf onto back pin then set down on front pin.

Pins  
 Thumbscrew

WHEN DISASSEMBLING TIGHTEN ALL KNOBS TO PREVENT LOSS DURING SHIPPING

Part Number	Description
A	Left Leg Assembly
B	Right Leg Assembly
C	Horizontal Extrusion
D	Horizontal Extrusion w/ Door Stopper

Step 1:

- A) Connect lower horizontal extrusion [C] between bottom of leg assemblies [A and B] as shown.
- B) Insert Laminated infill into grooves of leg assemblies [A and B].
- C) Attach extrusion door between leg assemblies [A and B] and atop laminated infill.
- D) Attach upper horizontal extrusion w/ door stopper [D] between leg assemblies [A and B], and set flush with top of legs [A and B].

**NOTE: Make sure the lock is flush with extrusion before tightening. If lock will not fully engage, gently rock lock and extrusion back and forth while turning knob until lock fully opens.**

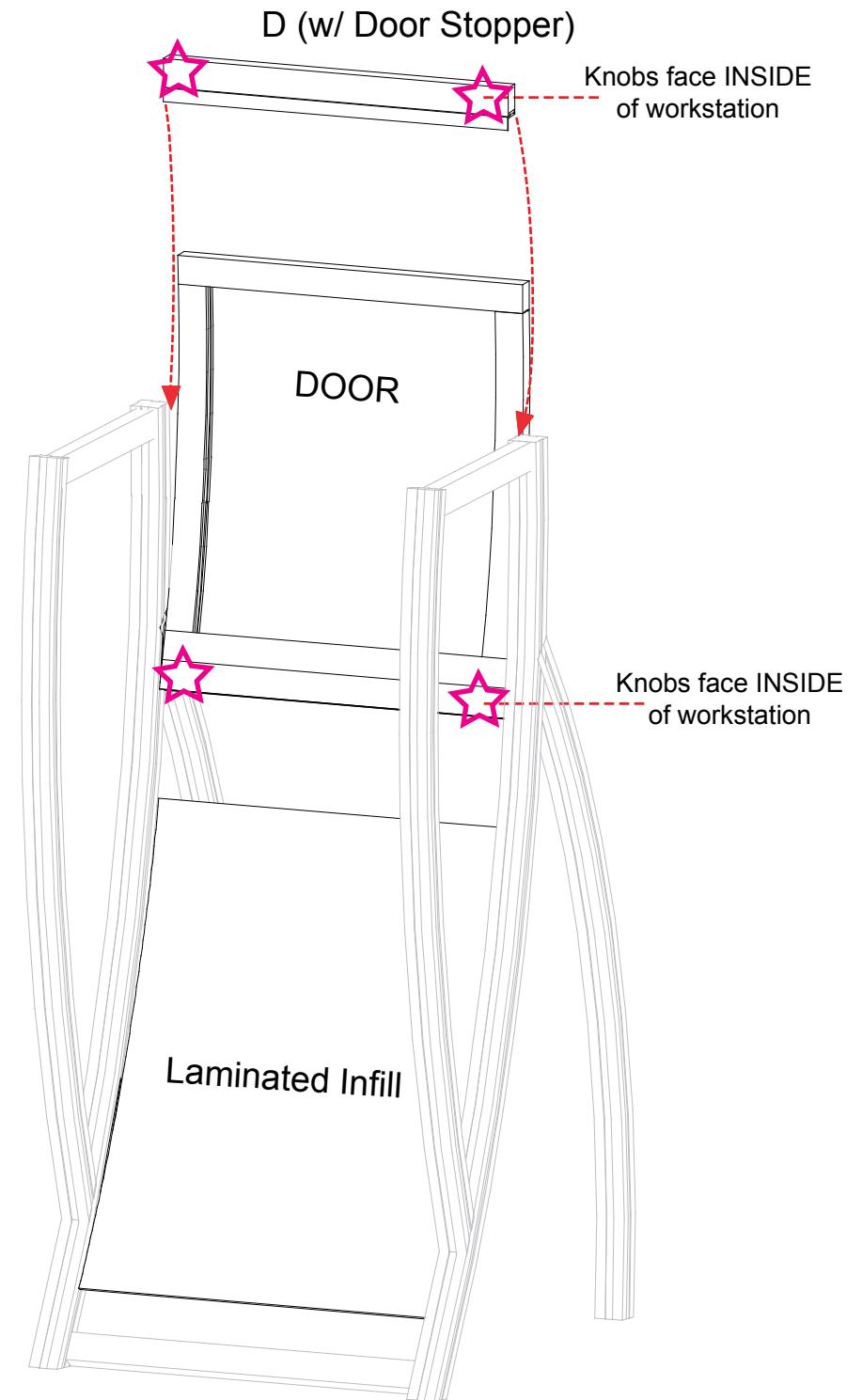
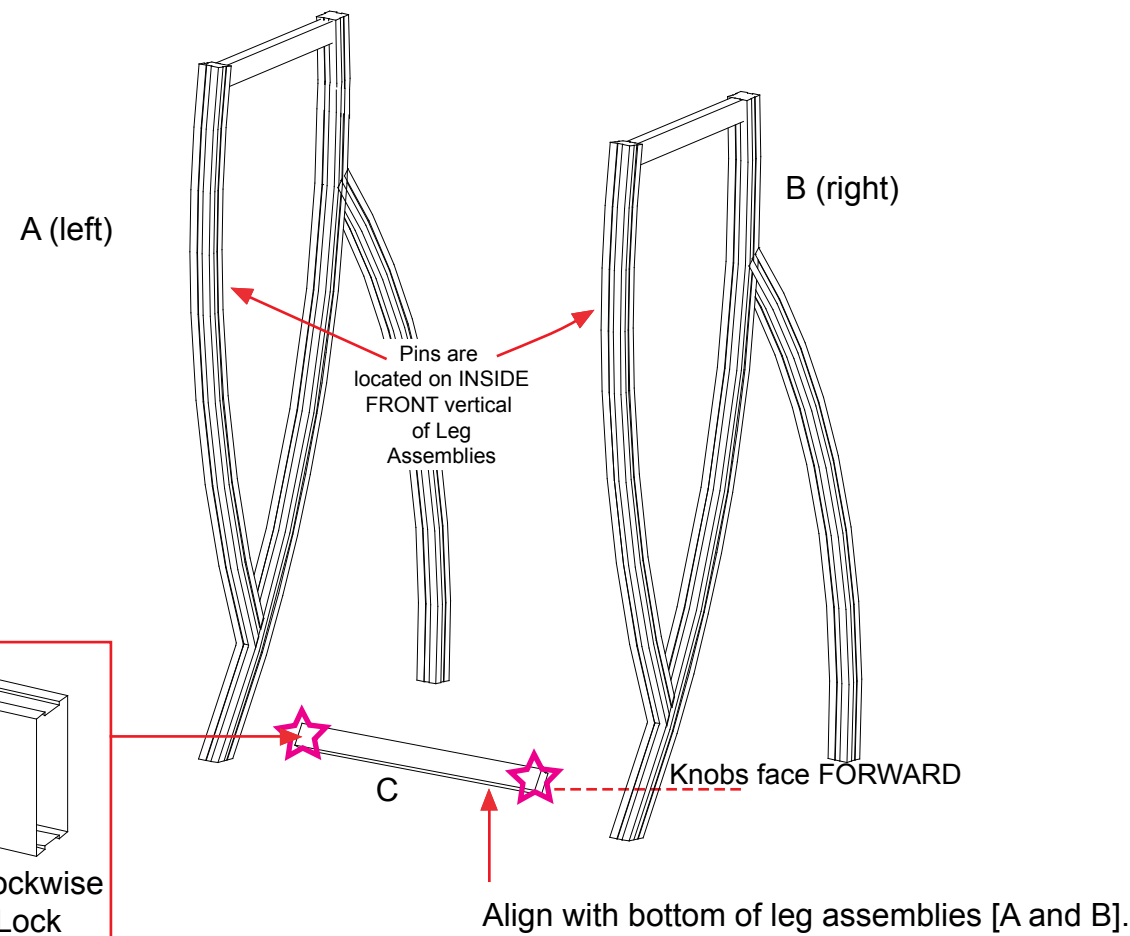

**WHEN DISASSEMBLING TIGHTEN ALL KNOBS TO PREVENT LOSS DURING SHIPPING**

866.652.2100

Step 2:

**\*\*REPEAT steps for both Pedestals**

- A) Attach laminated front panel to assembled pedestal using standoff caps as shown below.
- B) Place internal shelf into assembled pedestal atop pins..
- C) Set Counter atop assembled pedestal and secure with Velcro straps attached to underside of top.

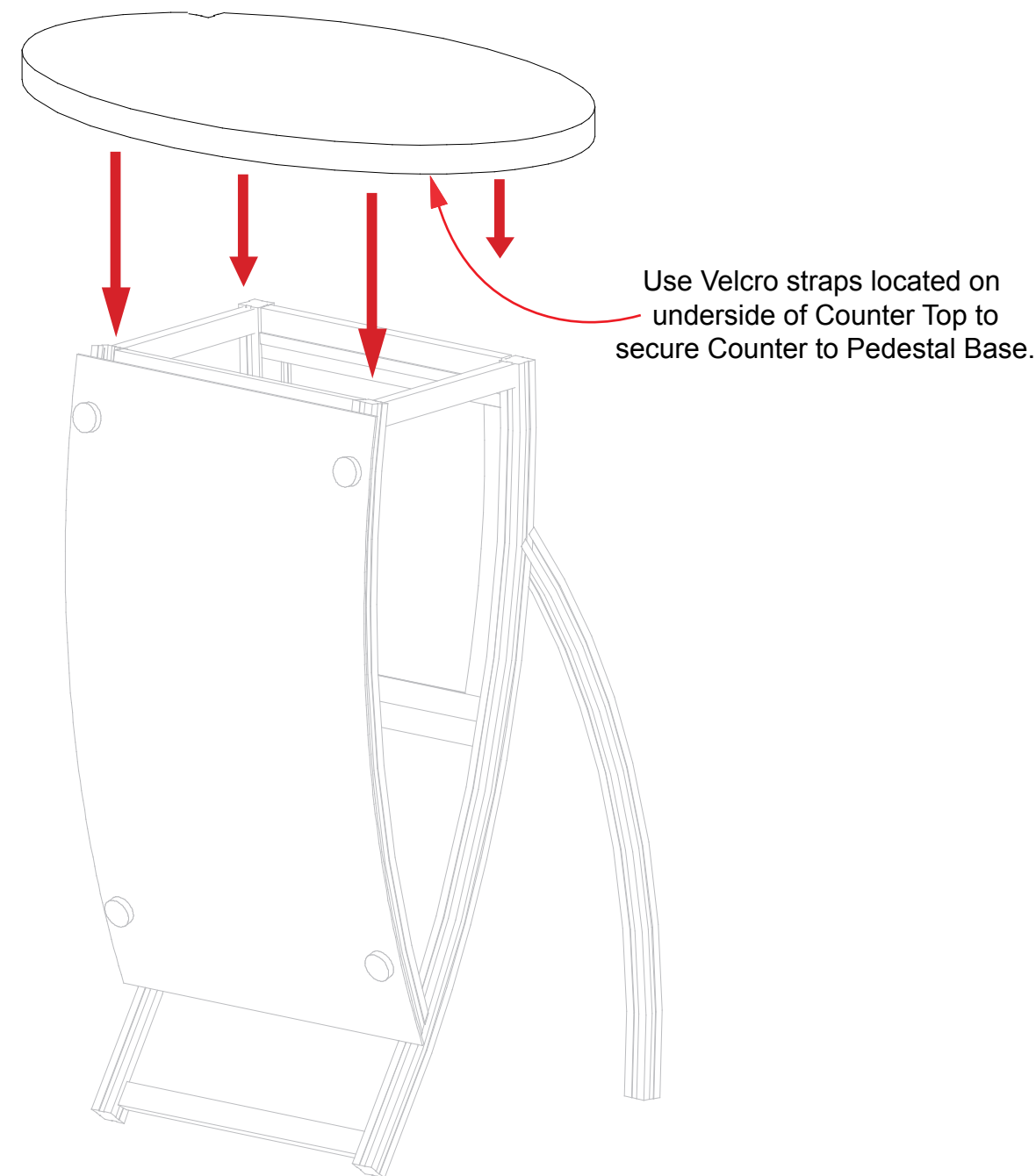
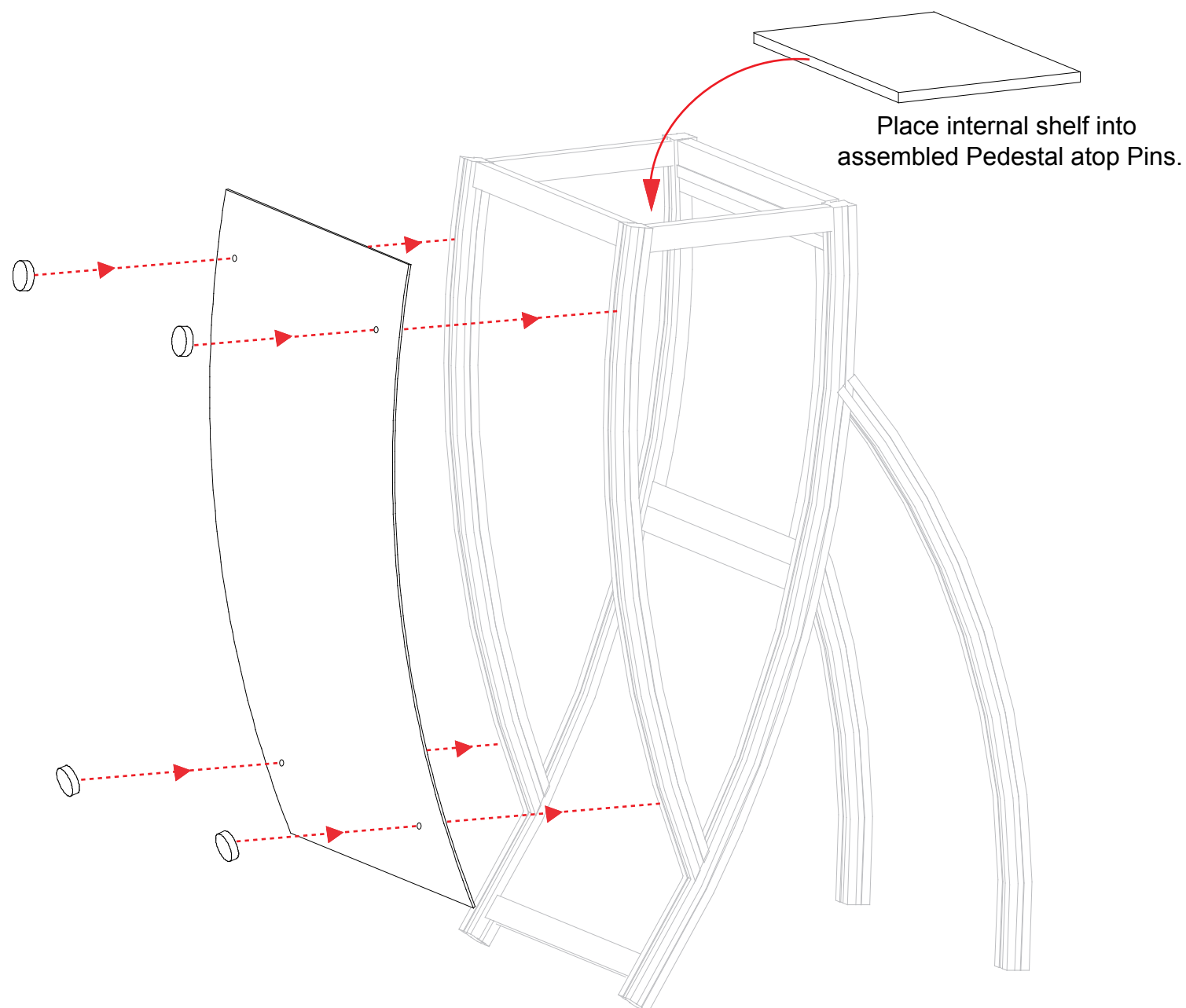

**WHEN DISASSEMBLING TIGHTEN ALL KNOBS TO PREVENT LOSS DURING SHIPPING**



866.652.2100

Part Number	Description
G	Curved Montior Mount Extrusion

- Step 3:
- A) Slide Connection Bar into lower leg assembly. Slide upper vertical over bar and secure both.
  - B) Attach flag to A10's located on curved vertical extrusion G.
  - C) Attach Monitor Mount to vertical as shown in Detail below.

**Decorative Wing Attachment**

Slide A10 Clamp into groove of square extrusion.

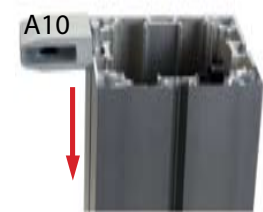

When desired location is found, tighten set screw to secure.



Tighten black plastic set screw to secure Wing in place.



Black Plastic Set-screw

**MONITOR MOUNT**

Attach monitor mount to vertical extrusions after assembly.

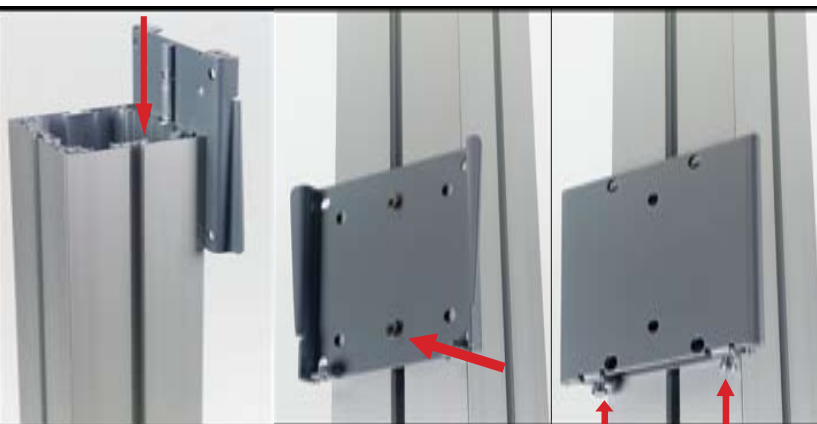

Slide Mount into Groove of Vertical Extrusion.

Tighten Setscrew

Attach top Plate and tighten screws

**Hex Key Tool**



(if necessary)

**Flathead Screwdriver**



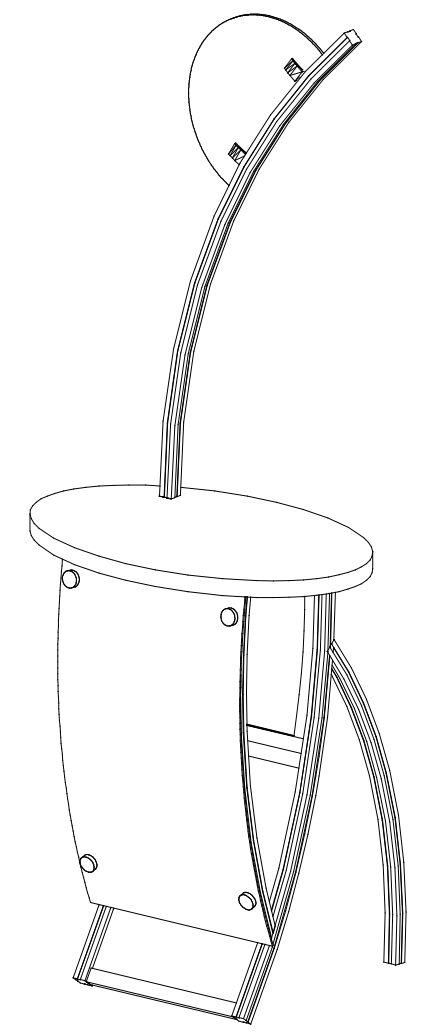
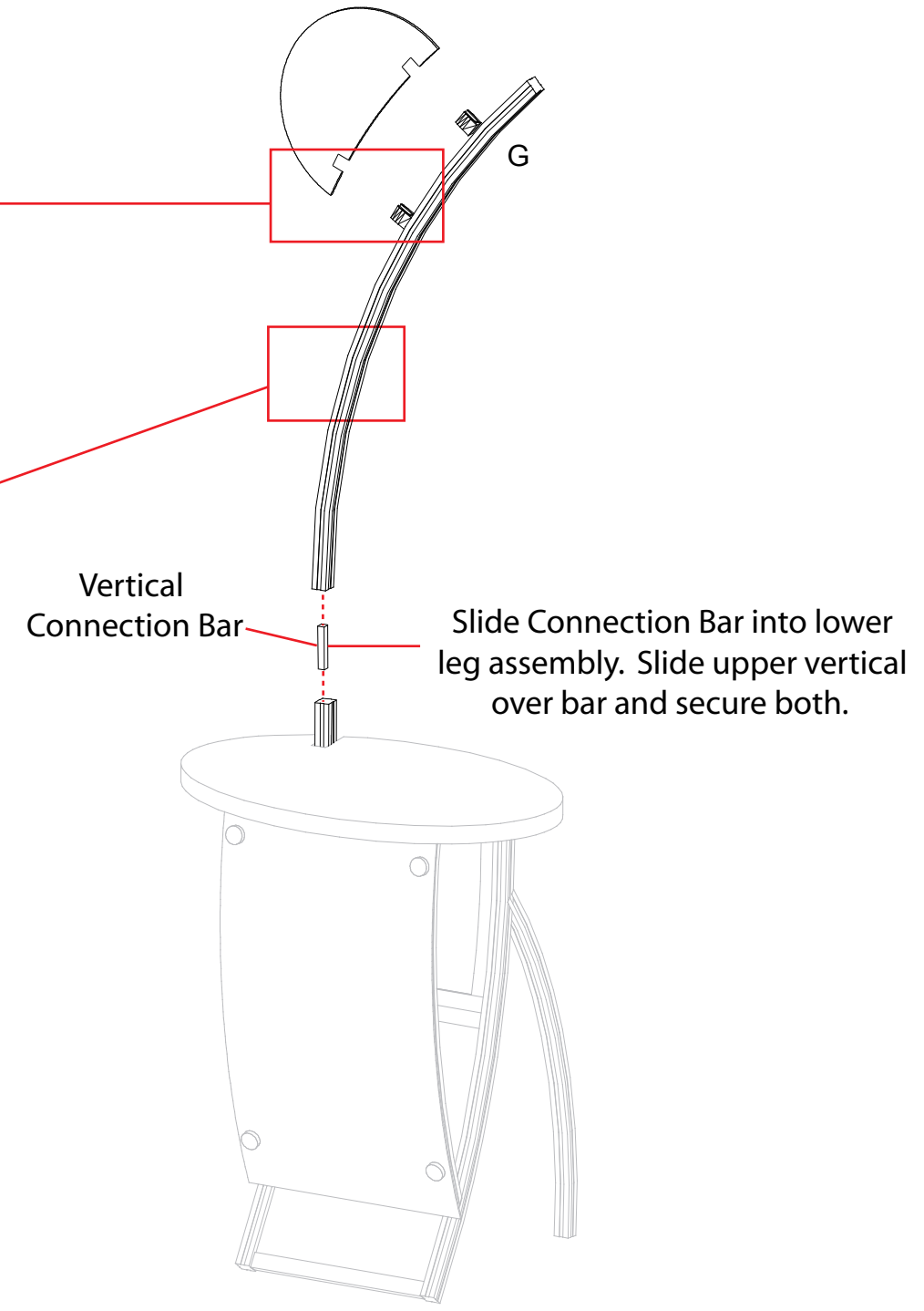

WHEN DISASSEMBLING TIGHTEN ALL KNOBS TO PREVENT LOSS DURING SHIPPING

Case #1 - Backwall Components

Top View of each Level

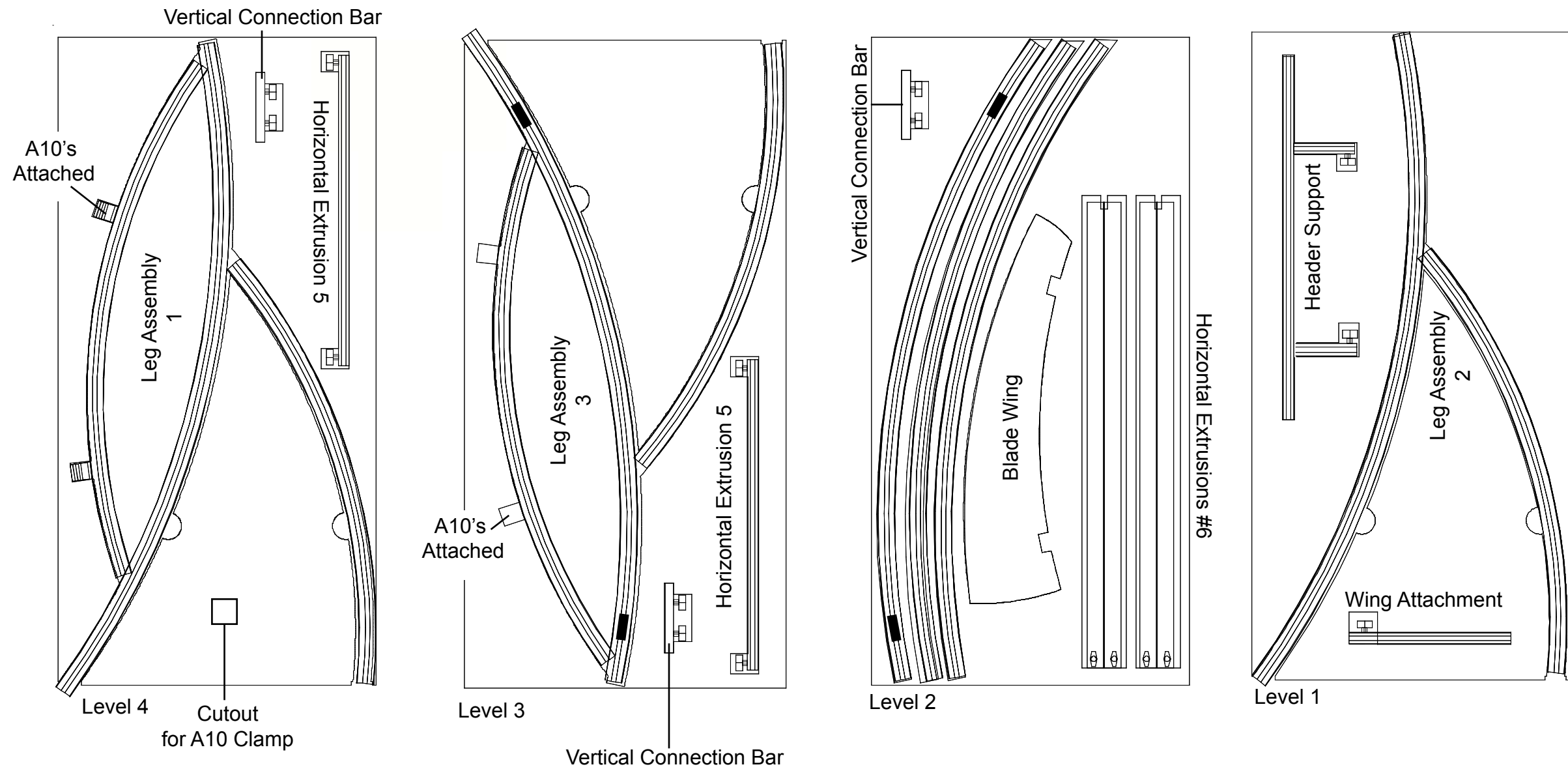

WHEN DISASSEMBLING TIGHTEN ALL KNOBS TO PREVENT LOSS DURING SHIPPING

Case #2 - Backwall Components

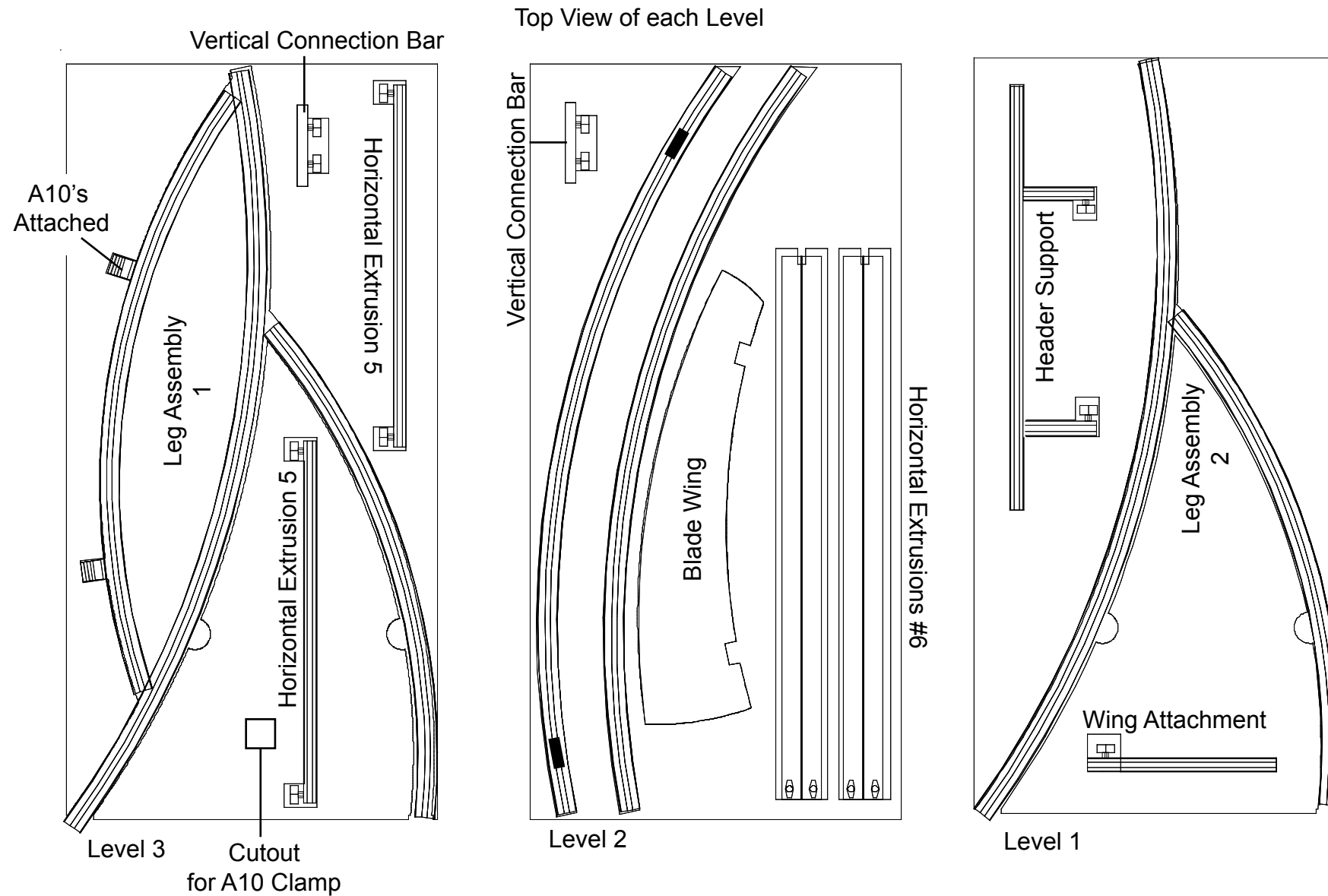

WHEN DISASSEMBLING TIGHTEN ALL KNOBS TO PREVENT LOSS DURING SHIPPING

Case #3 - Backwall Components

Top View of each Level

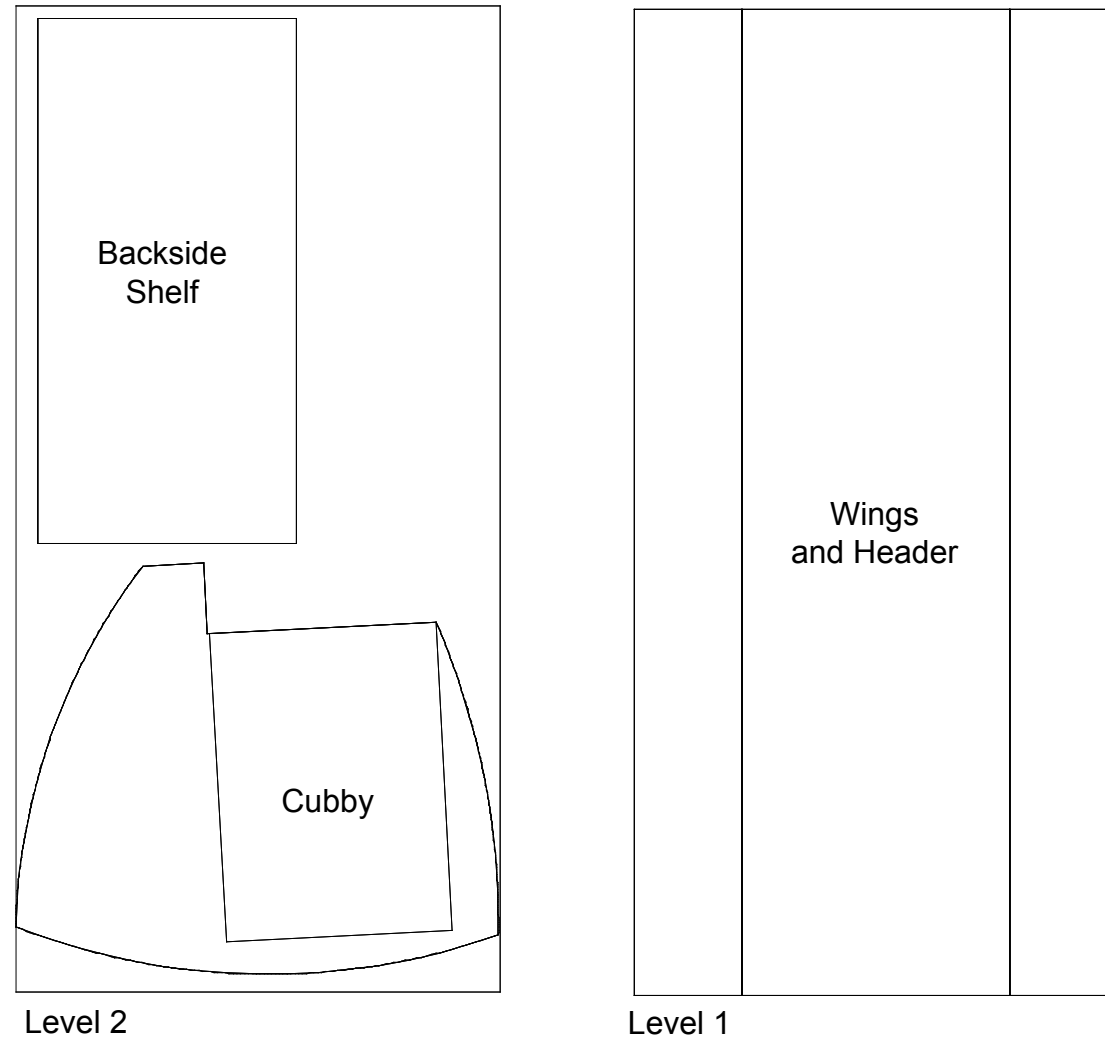

WHEN DISASSEMBLING TIGHTEN ALL KNOBS TO PREVENT LOSS DURING SHIPPING



Case #4 - Backwall Components

Top View of each Level

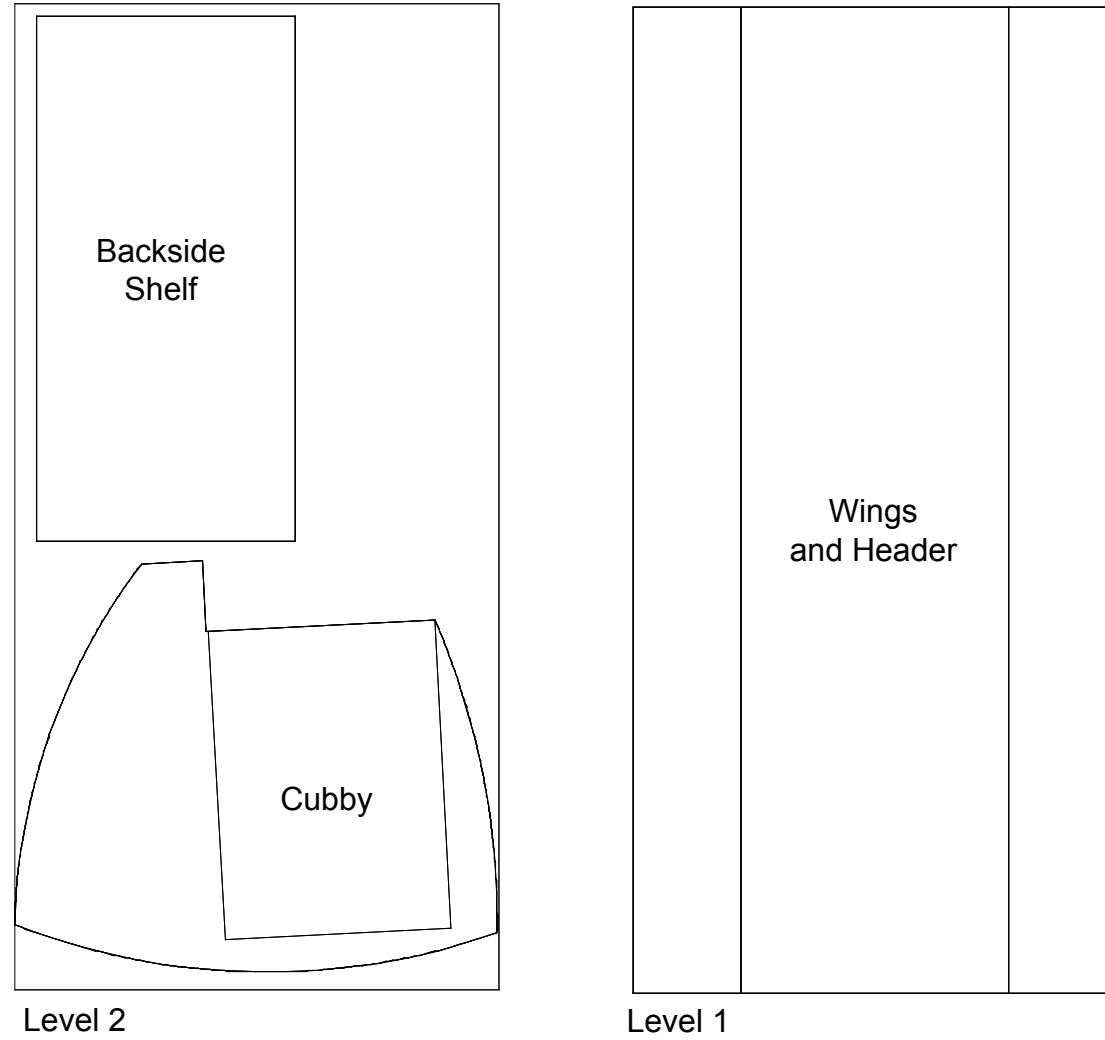

WHEN DISASSEMBLING TIGHTEN ALL KNOBS TO PREVENT LOSS DURING SHIPPING

Case #5 - Workstation Components

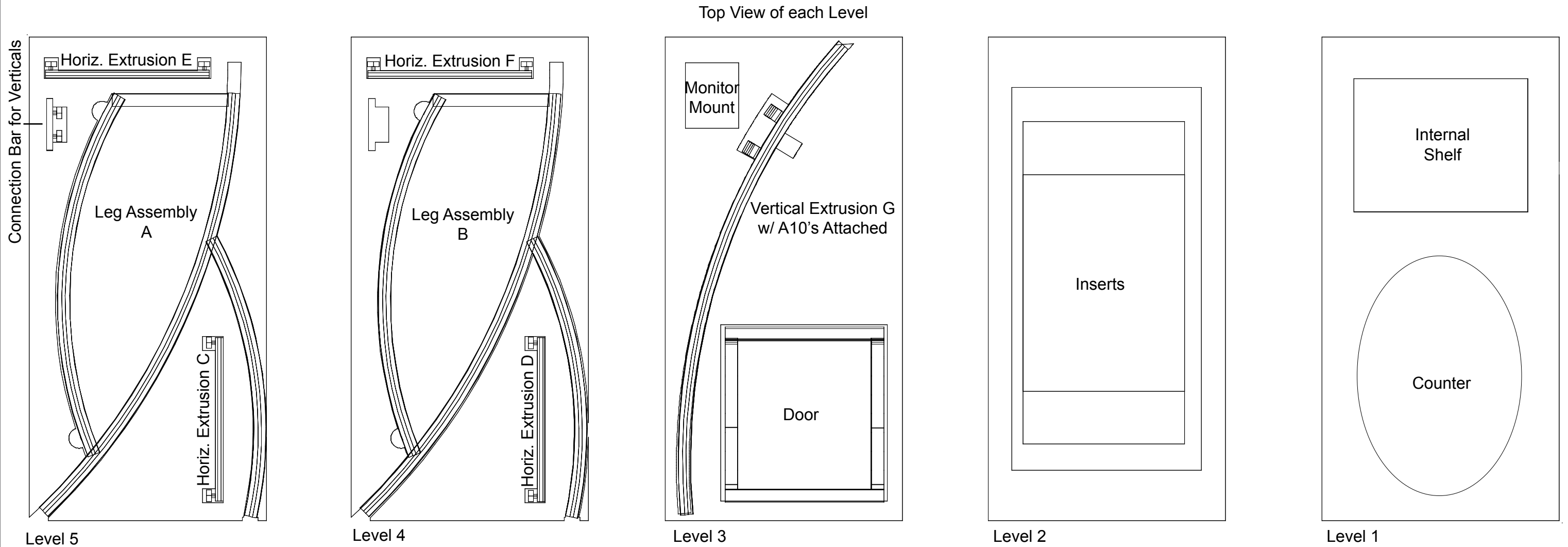

WHEN DISASSEMBLING TIGHTEN ALL KNOBS TO PREVENT LOSS DURING SHIPPING

Case #6 - Workstation Components

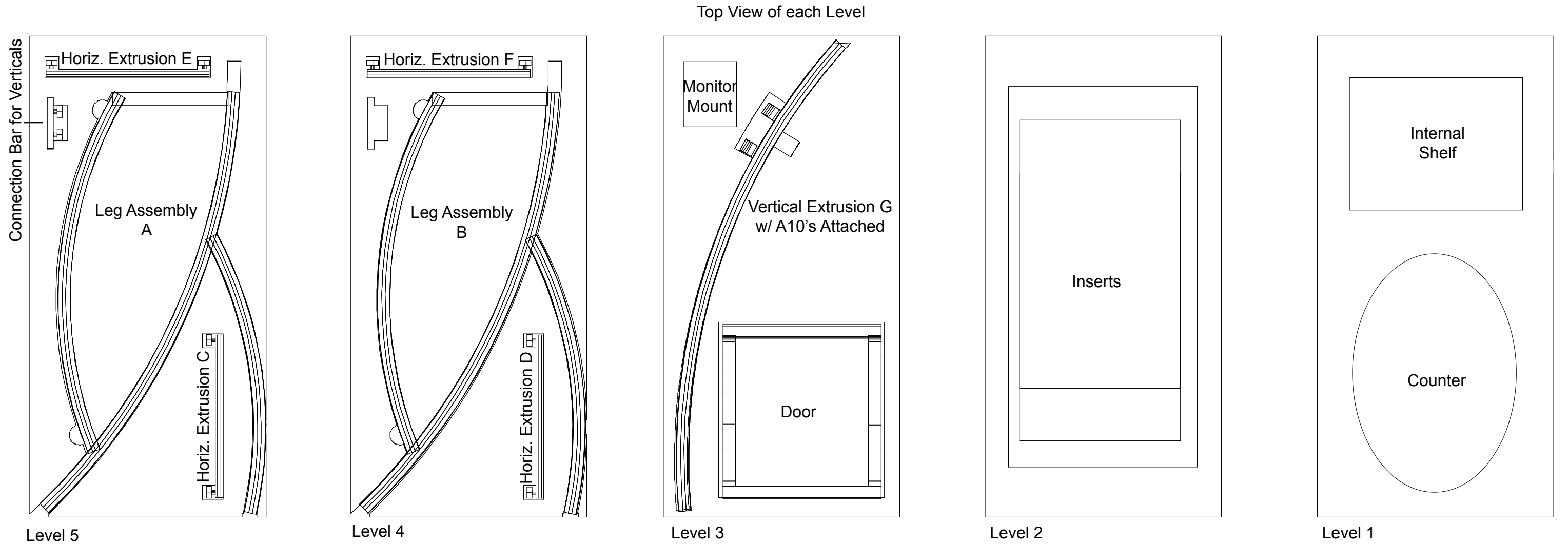

WHEN DISASSEMBLING TIGHTEN ALL KNOBS TO PREVENT LOSS DURING SHIPPING